

THE PECO PERFORMANCE PRO THERMOSTAT

Thank you for choosing a PECO® Performance PRO™ thermostat. The Performance PRO T8000 Series is intended for use in residential and commercial environments. It is designed for and can support up to 3-HEAT/ 2-COOL configurations in conventional systems and in heat pump applications. The Performance PRO also provides the capability to meet the requirements for ASHRAE 90.1-2004 and California Building Code Title 24 (2008 edition).

The Performance PRO T8000 Series is comprised of the T8000 non-programmable thermostat models and the T8500 programmable thermostat models. The T8000 Series features an 8 square inch blue backlit display with dynamic menus, accessed using soft keys. All Performance PRO T8000 Series offer the following standard features: auto-changeover, temporary override, optional remote sensors, occupancy sensors, three levels of keypad lockout, a PIN access code, a furnace filter change reminder, and a heat/cool Demand Indicator. In addition, the T8500 programmable models contain: up to four scheduled events per day, a 365-day calendar, 20 holidays, holiday override, temporary override, a Power Harvesting feature to preserve battery life (also known as "power stealing"), Secure Digital (SD) card capability (card not included), and optional humidity control (T8532-IAQ only).

The T8000 Series can be powered by 24 VAC or batteries or both (recommended). The T8000 Series can control up to 7 outputs and monitor three external sensors. The T8000 Series mounts onto any PECO Performance PRO Series wallplate.

APPLICATIONS AND FEATURES

The PECO Performance PRO thermostat is intended for use in conventional and heat pump applications.

- System mode selections: Off-Heat-Cool-Auto-Emergency
- Stages: 1 Heat/1 Cool, 2 Heat/1 Cool, 1 Heat/2 Cool; 2 Heat/ 2 Cool; 3 Heat/ /2 Cool
- Fan control: Cycling (Auto) or Continuous (On); 1 Speed
- Permanent memory: All device settings are stored in permanent memory.
- Connections for Remote Sensors (indoor, outdoor, and occupancy)
- SD card capability (card not included)

CAUTION!

- **24 VAC low-voltage thermostat. Do not install on voltages higher than 30 VAC.**
- **Use copper wire only; insulate or cap off (with wire nuts) all unused leads.**
- **Use care to avoid electrostatic discharge to the thermostat.**

FRONT PANEL REFERENCE: T8000/T8500 CONTROLS & DISPLAY

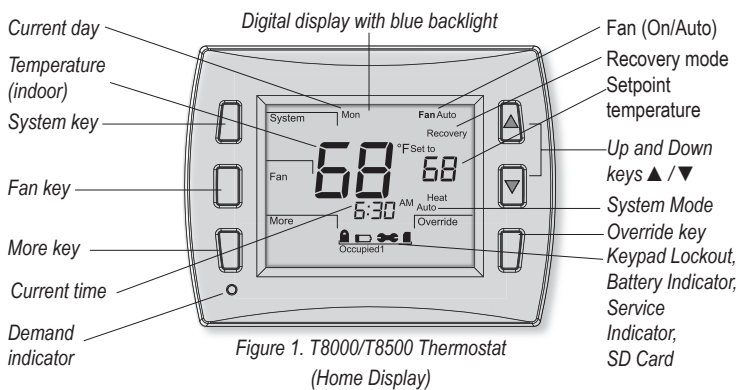

Figure 1. T8000/T8500 Thermostat (Home Display)

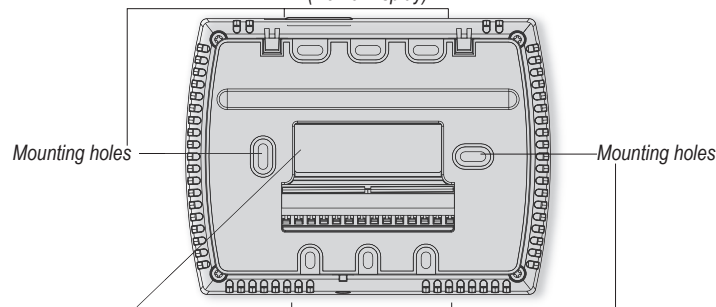

Figure 2. T8000/T8500 Thermostat back view (with wallplate attached).

WARNING

- READ THESE INSTRUCTIONS CAREFULLY BEFORE ATTEMPTING TO INSTALL, OPERATE OR SERVICE THIS THERMOSTAT.
- Failure to observe safety information and comply with instructions could result in PERSONAL INJURY, DEATH AND/OR PROPERTY DAMAGE.
- To avoid electrical shock or damage to equipment, disconnect power before installing or servicing and use only wiring with insulation rated for full thermostat operating voltage.
- To avoid potential fire and/or explosion do not use in potentially flammable or explosive atmospheres.
- Retain these instructions for future reference.
- This product, when installed, will be part of an engineered system whose specifications and performance characteristics are not designed or controlled by PECO. Review applications and national and local codes to assure that the installation will be functional and safe.

PRODUCT SPECIFICATIONS

Temperature Control

Range: 50° to 90° F (10° to 32° C)

Differential: 1° F (0.5° C)

Input Power: 24 VAC (20-30 VAC) 50/60 Hz (+/- 10%) or AA alkaline batteries (both recommended); 5mm terminals accept 14-24 AWG stranded or solid wire.

Operating Temperature: 0° to 120°F (-17° to 48°C)

Shipping Temperature: -20° to 130°F (-28° to 54°C)

Operating Humidity: 5% to 95% RH, non-condensing

Physical Dimensions: T8000/T8500 Thermostat: 4.3" H x 5.7" W x 1.3"D with 3.2" x 2.5" / 8 square inch liquid crystal display (LCD)

Output Ratings

Voltage (50/60 Hz): 20-30 VAC

Current: 0.02-1.0 A per terminal; W1 (B/O), W2 (AUX), G, A, E, Y1, Y2.

Note: Collectively, total current draw must not exceed 2.5 A.

INSTALLATION INSTRUCTIONS

Select an appropriate thermostat location

Locate the thermostat about four feet (1.2m) above the floor on a wall in an area with good ventilation and an average temperature, where it will be responsive to changes in room temperature.

The Performance PRO T8000 Series may be mounted on a:

- Horizontal or vertical 2" X 4" device box
- Horizontal 4" X 4" device box
- Flat surface

Do **not** locate the thermostat where it can be affected by:

- Direct sunlight
- Drafts or dead areas behind doors
- Radiant heat from appliances
- Concealed pipes or chimneys
- Outside walls or unheated/uncooled areas

Required components (not included, unless otherwise specified):

- Two new AA batteries (included)
- Screws and wall anchors (included)
- Screwdrivers: Phillips (for wallplate); small flathead (for terminal blocks)
- Drill with 3/16" drill bit (or 7/32" for plaster)
- Wirecutter and stripper
- Level
- Performance PRO T8000 Series Thermostat (included)
- Performance PRO T8000 Series Thermostat Operating Manual (included)

Note: Secure Digital (SD) card feature (card not included) is a quick configuration tool to transfer customized settings to or from the thermostat. For instructions, see "Load SD Card Settings" in the Operating Manual.

PART I: INSTALL THE WALLPLATE

1. Position the wallplate on the wall with the directional arrow pointing up (see Fig. 3) and terminal blocks facing outward.

Figure 3:
Position the wallplate on the wall. Pull wires through wiring passage.

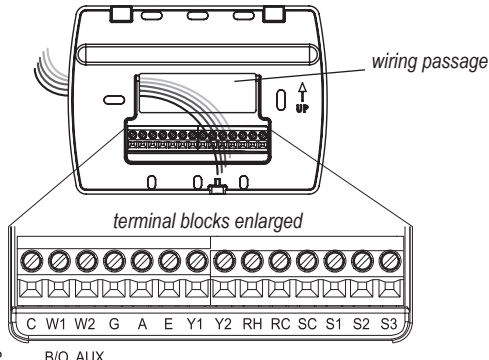

2. Pull equipment wires through the wallplate wiring passage (see Fig. 3).
3. Use a level to determine the best horizontal wallplate mounting position.
4. Mark positions of screw holes (two at minimum) with a pencil and remove wallplate.
5. Drill holes at pencil-marked locations (3/16" for drywall, 7/32" for plaster).
6. Insert the wall anchors in the holes, tapping them into place.
7. Mount the wallplate onto the wall and insert screws through mounting holes. Assume that all loose wires come through the center opening of the wallplate (see Fig. 3).
8. Cap off any unused wires and terminate properly according to local building codes.

PART II: ATTACH WIRES TO THERMOSTAT WALLPLATE

1. Select the terminal designations that correspond to the system type (see Table 1).



- **WARNING:** Disconnect power **before** beginning installation.
- **CAUTION:** Use copper wire only. Insulate or wire-nut all unused leads.
- Use care to **avoid** electrostatic discharge to thermostat

TABLE 1. TERMINAL DESIGNATIONS & SYSTEM TYPES

Conventional Terminal Letters		Heat Pump Terminal Letters	
C	Unswitched side, 24 VAC	C	Unswitched side, 24 VAC
W1	Stage 1 Heat	B/O	Reversing Valve
W2	Stage 2 Heat	AUX	Auxiliary (Stage 3 Heat)
G	Fan	G	Fan
A	Economizer/Damper/ Humidity	A	Economizer/Damper/ Humidity
E	Stage 3 Heat	E	Emergency Heat
Y1	Stage 1 Cool	Y1	Compressor Stage 1, Heat /Cool 1
Y2	Stage 2 Cool (or Dehumidify)	Y2	Compressor Stage 2, Heat /Cool 2 (or Dehumidify)
RH	Power for heating, switched side, 24 VAC	RH	Power for heating, switched side, 24 VAC
RC	Power for cooling, switched side, 24 VAC	RC	Power for cooling, switched side, 24 VAC
SC	Sensor Common	SC	Sensor Common
S1	Indoor Remote Sensor	S1	Indoor Remote Sensor
S2	Occupancy Setback Input*	S2	Occupancy Setback Input*
S3	Outdoor Remote Sensor	S3	Outdoor Remote Sensor

System Type 1: 1H/1C Conventional	
TERM	Function
C	Common
W1	Heat
W2	
G	Fan
A	Economizer/Damper
E	
Y1	Cool
Y2	
RH	Power for Heating
RC	Power for Cooling

System Type 2: 1H/1C Heat Pump	
TERM	Function
C	Common
B/O	Reversing Valve
AUX	
G	Fan
A	Economizer/Damper
E	
Y1	Compressor
Y2	
RH	Power for Heating
RC	Power for Cooling

System Type 3: Heat only (without fan)	
TERM	Function
C	Common
W1	Heat
W2	
G	
A	Economizer/Damper
E	
Y1	
Y2	
RH	Power for Heating
RC	

System Type 4: Heat only with fan	
TERM	Function
C	Common
W1	Heat
W2	
G	Fan
A	Economizer/Damper
E	
Y1	
Y2	
RH	Power for Heating
RC	

System Type 5: Cool only	
TERM	Function
C	Common
W1	
W2	
G	Fan
A	Economizer/Damper
E	
Y1	Cool
Y2	
RH	Power for Heating
RC	Power for Cooling

System Type 6: 2H/1C Heat Pump (Aux.)	
TERM	Function
C	Common
B/O	Reversing Valve
AUX	Auxiliary Heat
G	Fan
A	Economizer/Damper
E	Emergency Heat
Y1	Compressor
Y2	
RH	Power for Heating
RC	Power for Cooling

System Type 7: 2H/2C Conventional	
TERM	Function
C	Common
W1	Heat 1
W2	Heat 2
G	Fan
A	Economizer/Damper
E	
Y1	Cool 1
Y2	Cool 2
RH	Power for Heating
RC	Power for Cooling

System Type 8: 2H/1C Conventional	
TERM	Function
C	Common
W1	Heat 1
W2	Heat 2
G	Fan
A	Economizer/Damper
E	
Y1	Cool
Y2	
RH	Power for Heating
RC	Power for Cooling

System Type 9: 1H/2C Conventional	
TERM	Function
C	Common
W1	Heat
W2	
G	Fan
A	Economizer/Damper
E	
Y1	Cool 1
Y2	Cool 2
RH	Power for Heating
RC	Power for Cooling

System Type 10: 2H/2C Heat Pump	
TERM	Function
C	Common
B/O	Reversing Valve
AUX	
G	Fan
A	Economizer/Damper
E	
Y1	Compressor 1
Y2	Compressor 2
RH	Power for Heating
RC	Power for Cooling

i ALL ELECTRICAL LOADS MUST BE CONNECTED TO TERMINAL C (24 VAC).

*Note: Contact PECO to learn more about Occupancy Setback Input sensor applications.

System Type 11: 3H/2C Heat Pump	
TERM	Function
C	Common
B/O	Reversing Valve
AUX	Auxiliary Heat
G	Fan
A	Economizer/Damper
E	Emergency Heat
Y1	Compressor 1
Y2	Compressor 2
RH	Power for Heating
RC	Power for Cooling

System Type 12: 3H/1C Conventional	
TERM	Function
C	Common
W1	Heat 1
W2	Heat 2
G	Fan
A	Economizer/Damper
E	Heat 3
Y1	Cool 1
Y2	
RH	Power for Heating
RC	Power for Cooling

System Type 13: 3H/2C Conventional	
TERM	Function
C	Common
W1	Heat 1
W2	Heat 2
G	Fan
A	Economizer/Damper
E	Heat 3
Y1	Cool 1
Y2	Cool 2
RH	Power for Heating
RC	Power for Cooling

CAUTION: Do not connect unused wires together

PART II: ATTACH WIRES TO THERMOSTAT WALLPLATE (CONT.)

- Using a small flathead screwdriver, loosen the screws on the terminal blocks that correspond to the system type (see Table 1).
- Strip the insulation of each wire at a proper length (about 1/4" or 64 cm).
- On the wallplate, insert wires into the terminal blocks that correspond to the system type, then re-tighten each screw for each terminal (see Fig. 4, enlarged area).
Note: Do not over-tighten screws or use excessive force.
- Assure that no uninsulated wires are exposed: Cap off and place a wire-nut on any unused wires. Assure that the attached wires fit into the cavity on the back side of the thermostat.

Figure 4. Insert wires into appropriate terminal blocks.

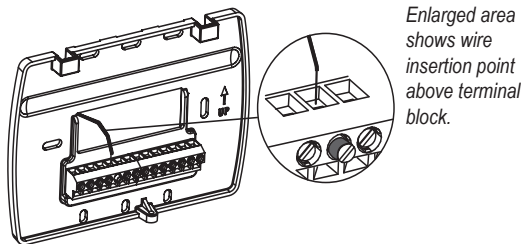

PART III: CONNECT POWER TO THE THERMOSTAT WALLPLATE

- Choose from the following options to power the thermostat.

Power Options

The T8000 Series will operate on 24VAC power and/or two AA batteries (both are recommended). Choose from three methods to connect power to the thermostat.

- Batteries only (AA alkaline)
- 24 VAC direct connection only
- 24 VAC with AA battery backup (highly recommended)

Wiring 24 VAC Common

- Single-Transformer System:** Connect the common side of the transformer to the "C" screw terminal of the thermostat wallplate. Assure that the metal jumper connects "RC" and "RH." Connect power side to the RC/RH and assure that the jumper remains in place.
- Two-Transformer System:** The T8000 Series is shipped with a jumper connecting terminals RH and RC. If the heating and cooling equipment do not use separate transformers, leave this jumper in place. If separate transformers are required, remove this jumper. With the jumper removed, connect RC to the power side of the cooling transformer. Connect RH to the power side of the heating transformer; then connect both the heating and cooling commons together to terminal C (Common).

PART IV: INSTALL BATTERIES & REMOVE TAB

- Insert two AA batteries (included) into the back compartment of the thermostat, where indicated (see Fig. 5).

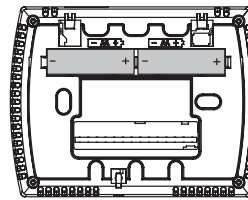

Figure 5. Insert two AA batteries in back of thermostat.

- Remove the plastic insulator tab from the back side of the thermostat (see Fig. 6).
IMPORTANT: The insulator tab must be removed before setting the real-time clock.

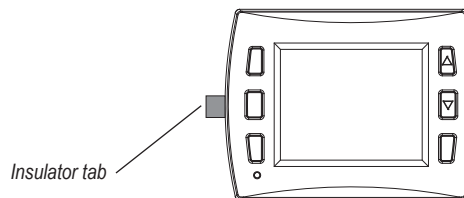

Figure 6. Remove the insulator tab from thermostat before operation.

PART V: SET THE CLOCK, MONTH, AND DAY

When power is first applied to the thermostat, it will activate the clock display. It is recommended that time and day are entered before performing advanced configuration. Follow the procedure below to set the clock, month, and day.

- Press ▲ / ▼ to select 12 or 24 HR mode, then press **Next**.
- Press ▲ / ▼ to select clock hour, then press **Next**.
- Press ▲ / ▼ to select clock minutes, then press **Next**.
- Press ▲ / ▼ to select clock year, then press **Next**.
- Press ▲ / ▼ to select current month, then press **Next**. **Note: Mo** (month) appears.
- Press ▲ / ▼ to select current date. **Note: Days** appears.
- Press **Done** to finish clock mode.

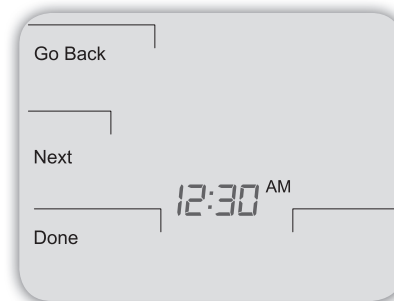

Figure 7. Clock must be set before performing advanced configuration.

PART VI: VERIFY SYSTEM SETTING IS TURNED OFF

Note: The flashing option is the default selection.

- Press any part of the touchscreen area to enter the Home Display.
- Press **System** to enter system settings.
- Press ▲ / ▼ to select "Off," then press **Done**.
- Press **Fan** key to enter fan mode.
- Press ▲ / ▼ to select "Auto," then press **Done**.

PART VII: PERFORM ADVANCED CONFIGURATION

Perform advanced configuration before attaching the thermostat to the wallplate. Advanced configuration is done by simultaneously pressing the lower left and lower right keys for about five seconds (See Fig. 8), which gives user access to Service Menus. Use Table 2 of this Installation Guide to set each desired Service Menu item. Advanced configuration allows the user to configure the thermostat to match the system type and to customize several thermostat settings.

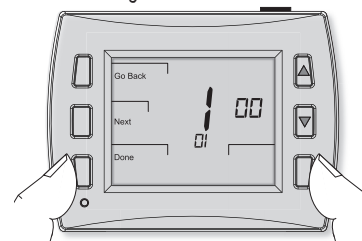
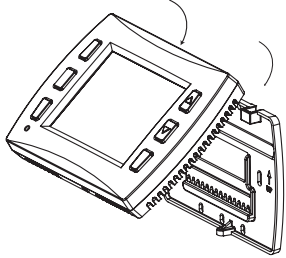

Figure 8. Access Service Menus by pressing the lower right and lower left keys simultaneously.

PART VIII: MOUNT THE T8000 ONTO THE WALLPLATE

1. Position the thermostat slightly above the mounted wallplate (see Fig. 9), then secure the hooks on the back side of the thermostat to the hinge pockets on the wallplate.
Note: The top back side of the thermostat should slip into the hinge pockets easily. Do not use excessive force.

Figure 9.
Secure the hooks on the back side of the thermostat to the hinge pockets on the wallplate.



2. Align the pins on the back side of the thermostat with the terminal blocks on the wallplate.
3. Gently bring down the thermostat onto the wallplate so the pins on the back of the thermostat fit into the terminal blocks on the wallplate (see Fig. 10).
4. Attach the retaining screw to the underside of the thermostat as shown (see Fig. 10).

Figure 10.
Mount the thermostat so pins on back fit into the terminal blocks on the wallplate.

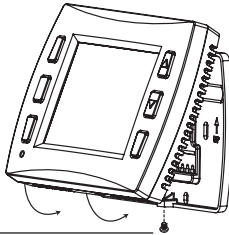

Retaining screw

PART IX: VERIFY THERMOSTAT OPERATION WITH SYSTEM TESTS

System test verification is highly recommended to verify thermostat operation. Follow at least one procedure in the system tests below. Refer to the Service Menus (see Table 2) for more system tests. For all system tests, press **Next** to continue to the following system test, which is the next available Service Menu. Press **Done** only if finished performing all system tests. Pressing **Done** exits the Service Menus and turns off all active outputs.

SYSTEM TEST MAIN OUTPUT (HEAT)

1. On the thermostat, press the lower left and lower right keys simultaneously for about five seconds. **Next**, **Go Back**, and **Done** appear (see Fig. 11).
2. Press **Next** until Service Menu 610 appears in the display. (Default value "00" appears below Service Menu.)

Figure 11.
Service Menu 610 allows user to perform System Test (Heat).

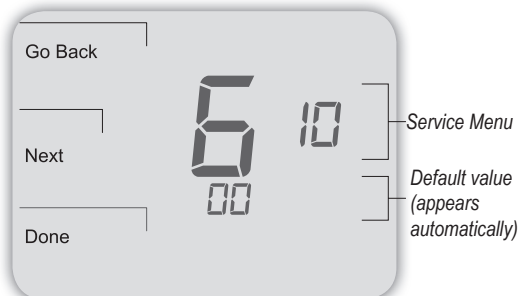

3. In Service Menu 610, press **▲** / **▼** to select option "01," Heat Stage 1 (see Fig. 12).
Note: If 01 is selected, the thermostat will activate the associated output for up to 10 minutes. The user should observe that the fan output (with heat) turns on. The user may also test more stages of heat according to what is available for the system type.

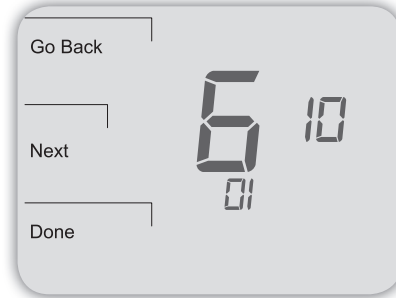

Figure 12.
Press Done to complete test and exit Service Menus or Next to continue to the next test.

4. Press **Done** to complete the system test and exit the Service Menus. After verifying the system test, the outputs are disabled and the fan will stop.

Optional: The user may perform additional system tests by pressing Next to access more Service Menus (see note below).

SYSTEM TEST FAN (OPTIONAL)

The following instructions assume that the user enters the Service Menus from the Home Display; it does not assume that the user has followed in sequence from the previous section. If continuing from the previous section on this page, skip to Step 2 below.

1. On the thermostat, press the lower left and lower right keys simultaneously for about five seconds. **Note:** **Next**, **Go Back**, and **Done** appear (see Fig. 13).
2. Press **Next** until Service Menu 620 appears in the display. (The default value "00" for appears below Service Menu.)

Figure 13.
Service Menu 620 allows user to perform a System Test Fan.

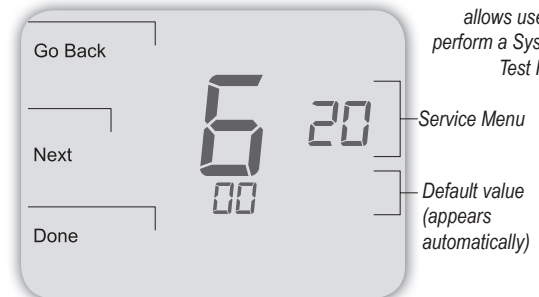

3. In Service Menu 620, press **▲** / **▼** to select option "01" (to enable fan output).
Note: If 01 is selected, the thermostat will activate the associated output for up to 10 minutes. The user should observe that the fan output will turn on.

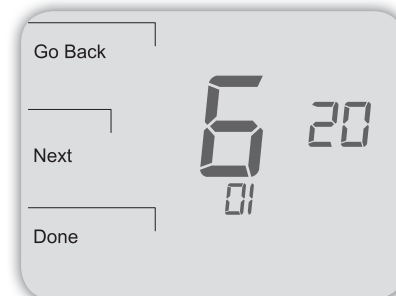

Figure 14.
Press Done to complete testing and exit Service Menus, or Next to continue tests.

4. Press **Done** to complete the system test. After verifying the system tests, the outputs are disabled.

Optional: The user may perform additional system tests by pressing Next. Additional system tests include (See Table 2): 600, System Test Main Output (Cool); 630, System Test Emergency Output; 640, System Test Economizer

TABLE 2. ADVANCED CONFIGURATION: SERVICE MENUS

To access Service Menus, simultaneously press lower left and lower right keys. Changed values are automatically retained. Service Menu availability is dependent upon system type and upon system configuration.

MENU	FEATURE	OPTIONS	STD. MODEL DEFAULT	DESCRIPTION / COMMENTS
100*	Schedule Format	0-3	1	Select the schedule format on the T8000 Series. (Menu not available on non-programmable thermostats.) 0 = nonprogrammable 1 = programmable 2 = 5-1-1 schedule 3 = 5-2 schedule
101	Daylight-Saving Time	0,1	0	Select daylight-saving time as it follows standard format in U.S.: It begins second Sunday of March at 2:00 AM and ends on the first Sunday of November at 2:00 AM. 0 = Disabled 1 = Enabled (2007 U.S. Format)
110	System Type	1-13	1	Select the appropriate system configuration (determines available Service Menus). 1 = 1 Heat/1 Cool conventional 2 = 1 Heat/1 Cool heat pump 3 = Heat only without fan (2-wire systems) 4 = Heat only with fan 5 = Cool only 6 = 2 Heat/1 Cool heat pump (with auxiliary heat) and Emergency (Em) heat 7 = 2 Heat/2 Cool multistage conventional 8 = 2 Heat/ 1 Cool multistage conventional 9 = 1 Heat/ 2 Cool multistage conventional 10 = 2 Heat/ 2 Cool heat pump (no auxiliary heat) 11 = 3 Heat/ 2 Cool heat pump (with auxiliary heat) and Emergency (Em) heat 12 = 3 Heat/ 1 Cool conventional 13 = 3 Heat/ 2 Cool conventional
120	Fan Control (heating)	0,1	0	0 = Fossil Fuel: Gas/Oil/Propane heat (equipment controls heating fan) 1 = Electric Furnace (thermostat controls heating fan)
130	Changeover valve (B/O terminal)	0,1	0	0 = B/O terminal controls valve in cooling 1 = B/O terminal controls valve in heating
140	Auxiliary Heat	0,1	0	0 = Electric backup heat 1 = Fossil fuel backup heat
150	Backlight	0,1	0	0 = Backlight temporarily on 1 = Backlight always on (low intensity, 24V only)
170	Remote Sensor	0-5	0	Select sensor if used. Contact PECO for information on the T8000 Series Indoor Remote Zone Sensor. 0 = No Sensor 1 = Indoor Sensor 2 = Outdoor Sensor display only 3 = Outdoor Sensor display and lockout control 4 = Indoor, Outdoor Sensor display only 5 = Indoor, Outdoor Sensor display and lockout control
180	Heat Pump Compressor Lockout	0-45°F (-18°C - 7°C)	0	If an outside sensor is used, the compressor will be locked out when the outside air temp is below the value selected. 0 = None 15°F (-9°C); 20°F (-7°C); 25°F (-4°C); 30°F (-1°C); 35°F (2°C); 40°F (4°C); 45°F (7°C)
190	Heat Pump Auxiliary Lockout	0- 60°F (-18°C - 15°C)	0	If an outside sensor is used, the auxiliary heat will be locked out when the outside air temperature is above the value selected. 0 = None 40°F (4°C); 45°F (7°C); 50°F (10°C); 55°F (13°C); 60°F (16°C)
230	Furnace Filter Change Reminder	0; 30; 60; 90; 120; 365	0	Set a filter reminder timer; appears on digital display when timer expires (if programmed). 0 = Off 10 days; 30 days; 60 days; 90 days; 120 days; 365 days
240	Number of Program Periods	2; 4 events	4	2 = 2 events per day 4 = 4 events per day
250	Clock format	12 or 24 Hours	12	12 = 12-hour clock mode 24 = 24-hour clock mode
260	Temperature Format (°F or °C)	0,1	1	0 = Celsius 1 = Fahrenheit
270	Fan Off Delay Heat	0-99 Seconds	0	Select the amount of time (in seconds) that the fan will run after the thermostat heat outputs are turned off.
280	Fan Off Delay Cool	0-99 Seconds	0	Select the amount of time (in seconds) that the fan will run after the thermostat COOL outputs are turned off.

TABLE 2. ADVANCED CONFIGURATION SERVICE MENUS (CONT.)

MENU	FEATURE	OPTIONS	STD.MODEL DEFAULT	DESCRIPTION / COMMENTS
290	Range Low	50-90 °F or 10-32°C	50°F (10°C)	Choose the <u>lowest</u> selectable temperature setpoint value.
300	Range High	50-90 °F or 10-32°C	90°F (32°C)	Choose the <u>highest</u> selectable temperature setpoint value.
310	Setback Low	Off; 50-82°F or 11-27°C	55°F (13°C)	Select the heat setpoint for setback mode. 0 = Off 50-82°F (11-27°C)
320	Setback High	Off; 58-90°F or 11-32°C	90°F (32°C)	Select the cool setpoint for setback mode. 0 = Off 58-90°F (11-32°C)
330	Zone Temp Offset	+/-9°F or +/- 4.5°C	0°F (18 °C)	Adjusts the displayed value; may differ from actual zone temperature.
340	Keypad Lockout	0-3	0	Restricts access to certain features of device; Service Menu still available if enabled. 0 = No key pad lockout (Default) 1 = Disables Schedule and System keys 2 = Disables Schedule, System, and Fan keys 3 = Disables all keys
341	Enable Pin Access	0,1	0	Applies a 3 digit access code to enter Service Menu 342 0 = Disable 1 = Enable
342	Set PIN Access Code	000-999	000	Choose a 3-digit code.
350	Fan Mode Enable	1-3	3	1 = ON: Fan is turned on regardless of demand. 2 = Auto: Fan is turned on according to heating or cooling demand. 3 = ON or Auto: Allows occupant to select either 1 or 2 above.
360	System Mode Enable	0-3	1	Allows ability to determine which system modes the occupant can select. 0 = OFF, Auto 1 = OFF, Heat, Cool, Auto 2 = OFF, Heat, Cool 3 = Heat, Cool, Auto
370	Economizer/Outside Air Damper	0-4	0	0 = Off 1 = Time Based Output 2 = Economizer 3 = Continuous Outside Air Damper 4 = Cycled Outside Air Damper
380	Minimum Deadband Adjustment	3-10°F, 1.5-5°C	3°F	Select a changeover deadband value to prevent short cycling between heating and cooling modes. The value is adjustable to meet various HVAC system requirements.
390	Pre-Occupancy Purge	0-3 hours	0 hours	Select to energize fan for selected number of hours (0-3) prior to all occupied events.
395	Maximum Override Time Limit	0=Time until next event; or 1-4 hours	3	Restricts the duration that a temporary hold can be set. The temporary hold is limited by the maximum amount of time as defined in this Service Menu. 0 = Remainder of time until the next scheduled event. 1 = 1 Hour 2 = 2 Hours 3 = 3 Hours 4 = 4 Hours
400	Cycles Per Hour (CPH) Cooling Stage 1	0-6 CPH	3 CPH	Defines the number of cycles per hour for cooling (Stage 1). Select 0 to enable ON-OFF control for Stage 1 cooling.
410	Cycles Per Hour (CPH) Cooling Stage 2	0-6 CPH	3 CPH	Defines the number of cycles per hour for cooling (Stage 2). Select 0 to enable ON-OFF control for Stage 2 cooling.
420	Cycles Per Hour (CPH) Heating Stage 1	0-12 CPH	5 CPH	Defines the number of cycles per hour for heating (Stage 1). Select 0 to enable ON-OFF control for Stage 1 heating.
430	Cycles Per Hour (CPH) Heating Stage 2	0-12 CPH	5 CPH	Defines the number of cycles per hour for heating (Stage 2). Select 0 to enable ON-OFF control for Stage 2 heating.

TABLE 2. ADVANCED CONFIGURATION SERVICE MENUS (CONT.)

MENU	FEATURE	OPTIONS	STD.MODEL DEFAULT	DESCRIPTION / COMMENTS
450	Cycles Per Hour (CPH) Emergency Heating & Stage 3 Heat	0-12 CPH	5 CPH	Defines the number of cycles per hour for heating. Select 0 to enable ON-OFF control for Emergency Heating & Stage 3 Heat.
460	Heat Recovery Rate	0-18°F/Hr 0-10°C/Hr	5°F/Hr	Defines the rate at which the device achieves the <u>heat</u> comfort setpoint. Select 0 to disable ramp recovery.
470	Cool Recovery Rate	0-18°F/Hr 0-10°C/Hr	5°F/Hr	Defines the rate at which the device achieves the <u>cool</u> comfort setpoint. Select 0 to disable ramp recovery.
480	Minimum Off Time	1-10 minutes	4 minutes	Sets the minimum off time for both the heat and cool output.
490	Humidity Control Enable (Select models only)	0-3	0	Selects how humidity will be controlled. When dehumidify control is enabled, the Y2 terminal becomes dehumidify. Note: If option 3 is selected, Service Menu 491 becomes available. 0 = Disabled 1 = Dehumidify Control 2 = Humidify Control 3 = Dehumidify and Humidify Control
491	Humidity Deadband	10-50	30% relative humidity (RH)	Selects the deadband in %RH between the humidify and dehumidify setpoints. Note: If option 3 is selected in Service Menu 490, Service Menu 491 becomes available. 10; 20; 30; 40; 50
500	Programmable/ Intermittent Fan	0-2	0	0 = Disable 1 = Programmable Fan: Fan operates continuously in occupied periods or with demand in unoccupied periods. 2 = Intermittent Fan: Fan operates based on the on and off times set in menus 501 and 502.
501	Intermittent Fan On Time	1-60 minutes	5 minutes	Defines the on time for the Intermittent Fan.
502	Intermittent Fan Off Time	0-60 minutes	25 minutes	Defines the off time for the Intermittent Fan. Select 0 for continuous fan.
510	Power Harvesting Enable (For use on systems in which a Common "C" power wire is unavailable)	0-3	0	Options 1-3 draw a small amount of current from load wire indicated to supplement battery supply. 0 = No power harvesting is available. 1 = Use Y1 as the battery supplement. 2 = Use W1 as the battery supplement. 3 = Use both Y1 and W1 as the battery supplement Warning: Power Harvesting is intended to be used only as a battery supplement. If enabled, the feature preserves battery life. If Power Harvesting is not compatible with your system, select "0" (default) to disable. If thermostat is powered from AC, select only "0" off. Consult a technician if you have questions.
520	Default Display Icons	0-4	0	Select icons that will be displayed in the Default Display screen. 0 = Time, Temp, SP 1 = Time, Temp 2 = Time 3 = Temp 4 = None
530	Revision	—	—	Displays firmware revision information (for technician); not adjustable.
540	Factory Default Reset	0,1	0	Select 1 (enable) to restore factory default settings for thermostat. Select 0 to disable. 0 = Disable 1 = Enable Note: Press "Done" key to complete process.
600	System Test Main Output (Cool)	0-2	0	Select an option to activate the fan output for 10 minutes; select 0, Done or a different Service Menu to disable. 0 = Disable 1 = Cool Stage 1 2 = Cool Stage 2
610	System Test Main Output (Heat)	0-3	0	Select an option to activate the fan output for 10 minutes; select 0, Done or a different Service Menu to disable. Note: Outputs will be activated based upon the system configuration. 0 = Disable (Default) 1 = Heat Stage 1 2 = Heat Stage 2 3 = Heat Stage 3
620	System Test Fan Output	0,1	0	Select 0 or 1 to activate the fan output for 10 minutes; select 0, Done or a different Service Menu to disable. 0 = Disable Fan Output 1 = Enable Fan Output Note: Outputs will be activated based upon the system configuration.
630	System Test Emergency Output	0,1	0	Select 0 or 1 to activate the Emergency output for 10 minutes; select 0, Done or a different Service Menu to disable. 0 = Disable Emergency Output 1 = Enable Emergency Output
640	System Test Economizer	0,1	0	Select 1 to activate the Economizer output for 10 minutes; select 0, Done or a different Service Menu to disable. 0 = Disable Economizer Output 1 = Enable Economizer Output

TABLE 3. TROUBLESHOOTING & FREQUENTLY ASKED QUESTIONS

In case of difficulty, try one of the following suggestions below.

Symptom	Potential Cause(s)	Solution
If display screen is blank	• Thermostat is not being powered	• Check to assure connection between Common (C) and (RC) for 24 VAC. • Check to assure that the metal jumper connects "RC" and "RH" (on single transformer system only). • Check to assure AA batteries are installed properly and are charged.
	• Default Display is set to "4" (None)	• Check Service Menu 520.
If display screen is blank AND system is running AC power only	• Power harvesting is enabled without battery support	• Install batteries and select "0" (disabled) in Service Menu 510 (to disable Power Harvesting).
If keys do not allow manual entry	• Keypad Lockout may be enabled	• Access Service Menu 340. Within this menu, select option "0" to assure there is no keypad lockout (so manual entry is enabled).
If Service Indicator (wrench) is on	• Remote temperature sensors may not be installed correctly or may be damaged.	• Check to assure that remote temperature sensor is connected properly. Ensure that the system uses PECO-approved sensor(s).
Setpoint limits do not change	• Heat or cool setpoint limit has been reached	• Check range limits and deadband (see Service Menus 290, 300, 380).
	• Keypad is locked	• See item above
If no heating or cooling is running, but there is a call for heat or cool (Heat/Cool appears on display) in Auto mode	• Heating or cooling equipment is not operating	• Check Service Menu 110 to assure that the correct option is selected to match the system type. • Check wiring, using output tests to verify (see Service Menus 600, 610, 620, 630, 640).
If heating and cooling system doesn't respond	• System type selection is incorrect	• Check Service Menu 110 to assure that the correct option is selected to match the system type.
If heating and cooling equipment are running at the same time	• System type selection is incorrect	• Check Service Menu 110 to assure that the correct option to match the system type is selected.
	• Heating and cooling wires are shorted together	• Separate the heating and cooling wires, using output tests to verify (see Service Menus 600, 610, 620, 630, 640).
Heat does not turn on (Heat is on continuously on display)	• Heating equipment failure • Loose or broken wire connection between heating equipment and thermostat	• Check for 24 VAC at the equipment on the secondary side of the transformer between the Power for Heating (RH) and the Common (C). • Check to assure 24 VAC connection between heat terminal (W1) and transformer Common (C). If 24 VAC is present, thermostat is functional. Check heating equipment to find cause of failure. If voltage is not present, check wire connection between the heating equipment and the thermostat.
If Demand Indicator light is red	• Heating is occurring	• No action is required.
If Demand Indicator light is green	• Cooling is occurring	• No action is required.
If Demand Indicator light is flashing	• An error has occurred • Remote sensor may be malfunctioning	• Check remote sensor wiring. • Verify that the sensor(s) are PECO supported products.
If heat pump issues cool air in heat mode or warm air in cool mode	• Changeover valve (B/O terminal) is not configured to match the heat pump	• Check Service Menu 130 to assure that the changeover valve (B/O terminal) is set to properly match the heat pump.
Cooling does not turn on (Cool is on display) in Auto mode	• Cooling equipment failure • Loose or broken wire between cooling equipment and thermostat	• Check for 24 VAC at the equipment on the secondary side of the transformer between the Power for Cooling (RC) and the Common (C). • Check to assure 24 VAC connection between the cool terminal (Y1) and transformer Common (C). If 24 VAC is present, thermostat is functional. Check cooling equipment to find cause of failure. If voltage is not present, check the wire connection between the cooling equipment and the thermostat.
If fan does not turn on when there is a demand for heat	• System type may be incorrect	• See Service Menu 110 and assure that the correct option is selected.
	• Fan control may be incorrect	• See Service Menu 120 and assure that the correct option is selected.
If heating system is running in the cool mode	• System type selection is incorrect	• Check Service Menu 110 to assure that the correct option is selected to match the system type.
If heating equipment does not turn off and heat temperature setting is set below room temperature	• Heating equipment is not a heat pump but system type selected is heat pump	• Check Service Menu 110 to assure that the correct option is selected to match the system type.
If the user cannot select the system setting for cool	• System type is set to Heat only or Heat only with fan	• Check Service Menu 110 to assure that the correct option is selected to match the system type.
If the user cannot select the system setting for heat	• System type is set to Cool only.	• Check Service Menu 110 to assure that the correct option is selected to match the system type.

PART X: SET PIN ACCESS FOR SERVICE MENUS (OPTIONAL)

Creating a PIN access code allows the installer to restrict access to Service Menus. First, a PIN access must be enabled in Service Menu 341; second, a three-digit code must be created in Service Menu 342. After these two Service Menus are properly configured, the thermostat requires the user to enter a PIN access code to enter the Service Menus.

1. On the thermostat, press the lower left and lower right keys simultaneously for about five seconds. **Next**, **Go Back**, and **Done** appear (see Fig. 15).
2. Press **Next** until Service Menu 341 (Enable/Disable PIN Access) appears in the display. (Default value appears below Service Menu.)

Figure 15. Service Menu 341 allows user to restrict access to Service Menus.

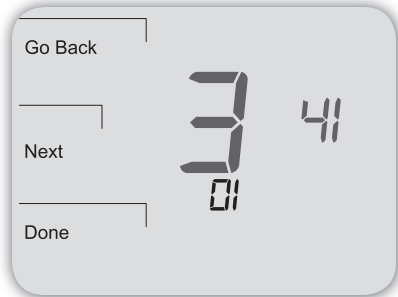

3. In Service Menu 341, press ▲ / ▼ to change digit (flashing) value to "01" (see Fig. 16). **Note: Selecting 01 enables PIN access for the thermostat Service Menus, and selecting it is necessary to show Service Menu 342.**
4. Press **Next**.
5. In Service Menu 342, press ▲ / ▼ adjust values and create a three-digit PIN access code. The flashing three-digit code appears in the clock area (see Fig. 16). **Note: Write down the PIN access code, and keep it in a safe place.**

Figure 16. Service Menu 342 allows user to create a PIN access code.

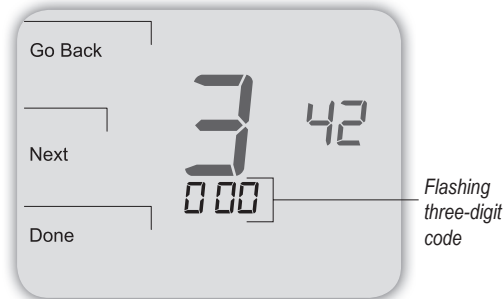

6. Press **Done** when finished.

VERIFY PIN ACCESS CODE

Enter the PIN access code upon entering the Service Menus. Note: Flashing digit is active; it is changed using the ▲ / ▼ keys. The active (editable) digit moves from right to left.

1. On the thermostat, press the lower left and lower right keys simultaneously for about five seconds. **Note: Flashing three-digit code, Next, and Done** appear (see Fig. 17).
2. Press ▲ / ▼ to change value of digit furthest to the right, then press **Next**.
3. Press ▲ / ▼ to change value of digit in middle, then press **Next**.
4. Press ▲ / ▼ to change value of digit furthest to left, then press **Done**. **Note: After step 4 is complete, user is allowed access to Service Menus. Next, Go Back, Done, and Service Menu 100** appear.

Figure 17. PIN access code flashes when user enters Service Menus (after enabling PIN access).

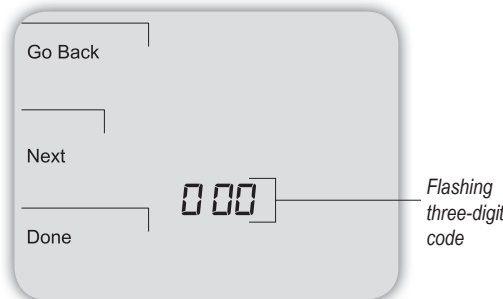

T8000 SERIES PERFORMANCE PRO ACCESSORIES: SENSORS

The following T8000 Series compatible sensors are available from PECO, providing optimal control of the environment. In addition, following are sensor wiring diagrams for temperature averaging, Indoor Remote Zone Sensor installation instructions, and Outdoor Remote Sensor installation instructions.

PECO SENSORS	Model Number	Part Number	Terminal	T8000	T8500
Indoor Remote Sensor	SP155-017	69308	S1	✓	✓
Occupancy Sensor	SB200-001	68375	S2	✓	✓
Outdoor Remote Sensor	--	70327	S3	✓	✓

To learn more about the benefits of PECO sensors visit www.pecomanufacturing.com. Or call 1-800-874-8547 to speak with a service representative.

TABLE 4. ZONE SENSOR MAXIMUM LENGTH AND WIRE SIZE

Distance from Unit to Control	Recommended Wire Size
000 - 150 feet	22 gauge
151 - 240 feet	20 gauge
241- 385 feet	18 gauge
386 - 610 feet	16 gauge
611 -970 feet	14 gauge

NOTE: Use appropriate wire for outdoor use.

LOCATE & MOUNT PECO OCCUPANCY SENSOR (SB200-001)

Please use the installation instructions for the SB200-001 to mount the PECO Occupancy Sensor SB200-001.

SENSOR WIRING FOR TEMPERATURE AVERAGING

Figure 18. Wiring four SP155-017 (10K ohm) temperature sensors.

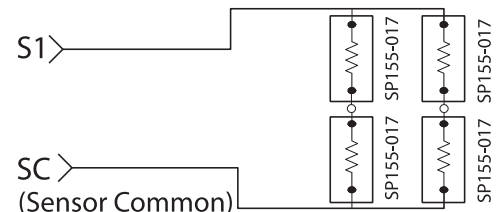
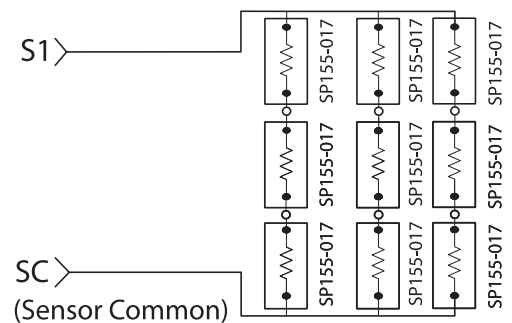

Figure 19. Wiring nine SP155-017 (10K ohm) temperature sensors.



LOCATE & MOUNT PECO INDOOR REMOTE ZONE SENSOR (SP155-017)

! WARNING

- READ THESE INSTRUCTIONS CAREFULLY BEFORE ATTEMPTING TO INSTALL, OPERATE, OR SERVICE THIS SENSOR.
- Failure to observe safety information and comply with instructions could result in PERSONAL INJURY, DEATH AND/OR PROPERTY DAMAGE.
- To avoid electrical shock or damage to equipment, disconnect power before installing and use only wiring with insulation rated for full sensor operating voltage.
- This product, when installed, will be part of an engineered system whose specifications and performance characteristics are not designed or controlled by PECO. Review applications and national and local codes to assure that the installation will be functional and safe.
- Do not run low-voltage control wiring in the same conduit with high-voltage wiring.
- Use in indoor applications only.

Figure 20. SP155-017 Indoor Remote Zone Sensor, front and side view.

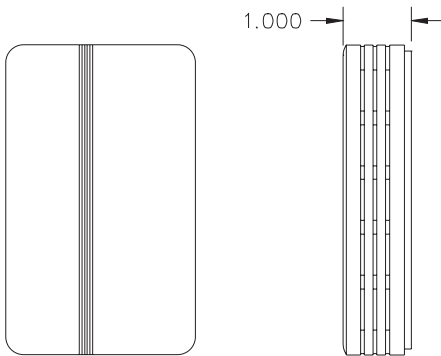
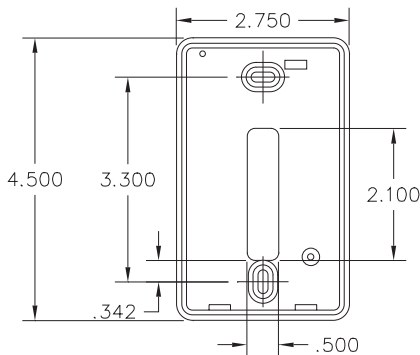

Figure 21. SP155-017 Indoor Remote Zone Sensor, back view with mounting holes.



INSTALLATION

1. **Mounting location.** Choose a location on an interior wall near the air return grille, about five feet above floor level, where air circulation is good and temperature is average for the zone.
 - Avoid** mounting the Indoor Remote Zone Sensor in areas such as:
 - Behind doors
 - On outside walls, or any walls with unheated or uncooled areas behind the zone sensor
 - In direct sunlight, or near any source of radiant heat that could affect the temperature measurements
 - In line with the discharge air from the unit being controlled.

2. **Mount subbase.** Remove Zone Sensor cover from the subbase, and mount subbase on the wall or in a 2' X 4" device box. Route the wires through the wire access hole in the subbase (see Fig. 22). Seal the hole in the wall behind the subbase.

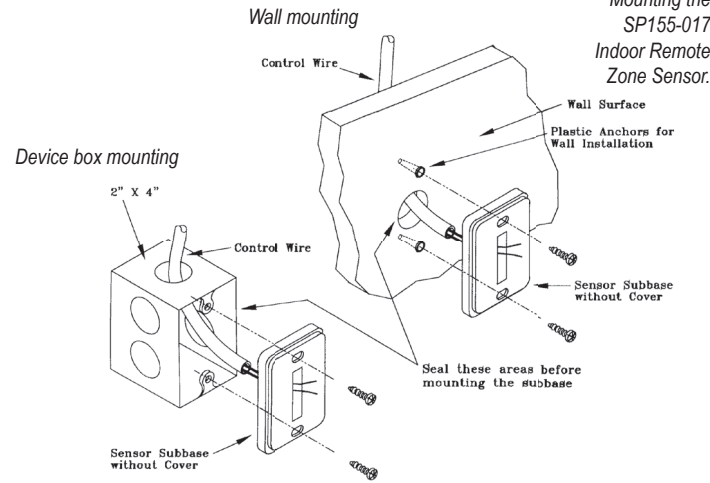

Figure 22. Mounting the SP155-017 Indoor Remote Zone Sensor.

WIRING

1. **Run wires.** Run wires between the unit control panel and the Zone Sensor subbase.
 - CAUTION:** Keep wires separate and routed away from any source of noise such as motors, fluorescent lights, and other wiring.
2. **Connect wires.** Connect the wiring to the terminals at the thermostat wallplate (S1 and SC) See Fig. 23, below.

Note: See Table 1 for terminal designations for the Indoor Remote Zone Sensor.

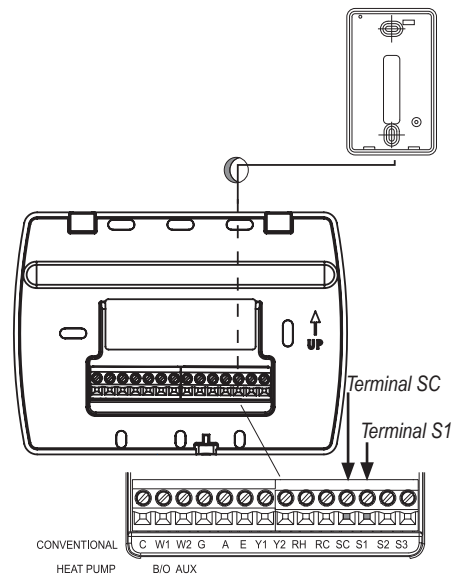

Figure 23. Wiring terminal designations for SP155-017 Indoor Remote Zone Sensor.

3. **Replace cover.** Place Zone Sensor cover back on the subbase, and snap it securely into place.
4. **Go to Service Menu 170.** Select option "01" to enable the Indoor Sensor (see Fig. 24).

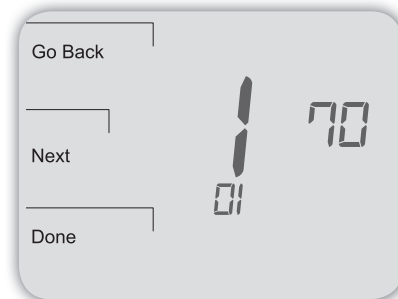

Figure 24. Service Menu 170 allows the user to enable the Indoor Remote Zone Sensor.

If the Indoor Remote Zone Sensor is working properly, the primary display (center) shows the correct temperature taken at the location where Indoor Remote Zone Sensor is currently installed (see Fig. 25).

Figure 25. Thermostat Display shows temperature from Zone Sensor if working properly.



TROUBLESHOOTING: INDOOR REMOTE ZONE SENSOR

If the thermostat Home Display appears as follows (see Fig. 26), then the Indoor Remote Zone Sensor is not connected properly. Two dashes and the Service Indicator (wrench) appear as the error message.

Figure 26. Thermostat Display shows Zone Sensor error message if Sensor is not working properly.

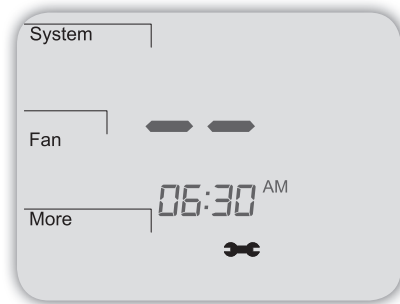

If the Indoor Remote Zone Sensor is not connected properly, check the following:

- Make sure sensor is wired properly and connected to terminals S1 and SC on the thermostat wallplate (see Table 1, Terminal Designations & System Types).
- If using multiple sensors, make sure wiring follows diagrams in Sensor Wiring for Temperature Averaging.
- Make sure to select "01" in Service Menu 170.

LOCATE & MOUNT PECO OUTDOOR REMOTE SENSOR

Following are instructions on the PECO Outdoor Remote Sensor (P/N 70327).

Mount the sensor where:

- It can measure true outdoor ambient temperature
- There is good air and circulation
- Surface is flat
- Wire distance between the sensors cannot be tampered with

Do not mount the sensor in any of the following:

- In direct sunlight
- Where hot or cold air blows on the sensor. Discharge line from an outdoor compressor unit, vent, or fan causes inaccurate temperature readings
- Where snow, ice, or debris can cover it

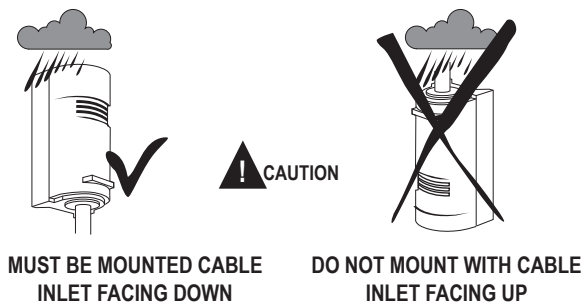

INSTALLATION

Use the following steps to mount the Outdoor Remote Sensor.

STEP 1

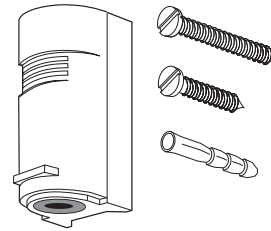

STEP 2

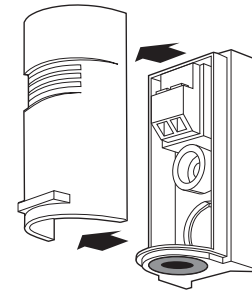

STEP 3

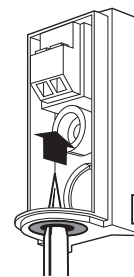

STEP 4

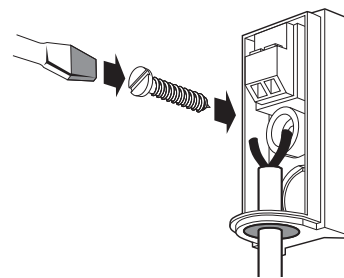

STEP 5

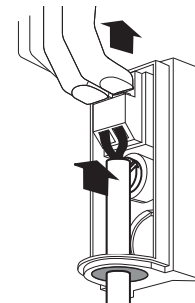

STEP 6

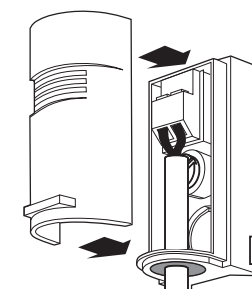

WIRE PECO OUTDOOR REMOTE SENSOR

1. Wire the PECO Outdoor Remote Sensor (P/N 70327) to Terminal S3 and Sensor Common (SC) on the thermostat backplate (see Fig. 27).
Note: See Table 1 for terminal designations for the Indoor Remote Zone Sensor.
2. Assure that Step 6 (previous section) is complete and the PECO Outdoor Remote Sensor is secure.
3. Plug the wiring passage using non-hardening caulk or putty.

Figure 27.
Wire PECO Remote Outdoor Sensor to Performance PRO wallplate, Terminal S3, SC.

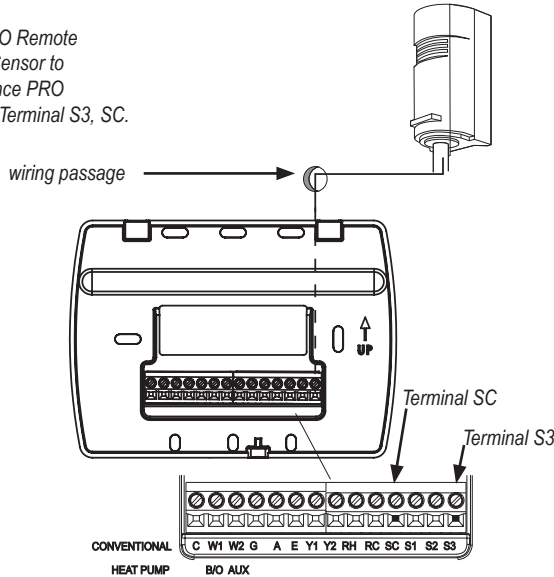

4. Go to Service Menu 170, select from options 2-5, Outdoor Remote Sensor (see Fig.28).

Figure 28.
Service Menu 170 allows the user to enable the Outdoor Remote Zone Sensor.

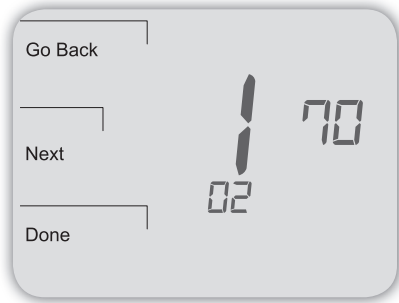

ECONOMIZER / TIME-OF-DAY (TOD) LOGIC

Allow the outdoor or indoor temperature sensor to absorb the air for a minimum of five minutes before taking a reading. See Service Menu 370 for controls the Economizer/ Outside air damper behavior. Table 5 shows the Economizer/TOD behaviors of available settings (Options include 0-4; 0 = OFF, which disables the Economizer function).

TABLE 5. Economizer Output

Effective Occupancy	Cooling Demand	370 = 1 (TOD)	370 = 2 (Economizer)
Occupied	N/A	ON Continuously	ON Continuously
Unoccupied	YES	OFF	ON (Cycles with demand)
	NO	OFF	OFF
Override	NA	ON Continuously	ON Continuously

Demand	System Mode	370 =3 (Continuous OA)	370 = 4 (Cycled OA)
Heating	Heat	ON Continuously	ON (Cycles with demand)
Cooling	Cool	ON Continuously	ON (Cycles with demand)
None	OFF	OFF	OFF
Heating or Cooling	Auto	ON Continuously	ON (Cycles with demand)

HEAT PUMP TEMPERATURE LOCKOUTS

Note: The options available in Service Menu 140 (below) are dependent on the selected System Type, Service Menu 110.

DUAL FUEL HEAT PUMP AND REMOTE OUTDOOR REMOTE SENSOR

In this operation, there is no external fossil fuel kit (dual fuel kit) installed; the thermostat controls this function:

1. Choose the correct heat pump application in Service Menu 110, System Type.
2. Choose Outdoor Temperature Sensor (Options 3 or 5) for Control Option in Service Menu 170, Remote Sensor.
3. Go to Service Menu 140, Auxiliary Heat, and choose "1."
4. Choose an appropriate temperature balance point in Service Menu 180, Heat Pump Compressor Lockout.

Operation in Heat Mode Above Balance Point (Outdoor Temperature)

When the outdoor temperature is above the selected balance point temperature (Service Menu 180), only the compressor operates and the fan (G Terminal) energizes when the thermostat calls for heat.

Operation in Heat Mode Below Balance Point (Outdoor Temperature)

When the outdoor temperature is below the selected balance point temperature (Service Menu 180), only the Fossil Fuel (auxiliary heat) operates and the fan (G Terminal) does not energize when the thermostat calls for heat.

FOSSIL FUEL AUXILIARY HEAT

If Service Menu 140 is set to "1" (fossil fuel Auxiliary Heat), the lockout control is as follows:

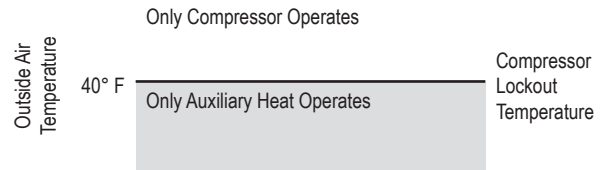

HEAT PUMP WITH AUXILIARY (BACKUP) HEAT AND OUTDOOR TEMPERATURE SENSOR

1. Choose the correct heat pump application in Service Menu 110, System Type.
2. Choose Outdoor Temperature Sensor (Options 3/5) for Control Option in Service Menu 170, Remote Sensor.
3. Go to Service Menu 140, Auxiliary Heat, and choose "0."
4. Choose appropriate balance point in the Service Menu 180, Heat Pump Compressor Lockout.
5. Choose Auxiliary Lockout Temperature in Service Menu 190, Heat Pump Auxiliary Lockout.

Note: There is a minimum 5°F deadband between Compressor and Auxiliary Heat lockout temperatures.

Operation

When the outdoor temperature is:

- Below the Heat Pump Compressor Lockout temperature, only the Auxiliary Heat operates.
- Above the Heat Pump Auxiliary Lockout Temperature, only the Compressor operates.
- Between the two temperatures, both the Compressor and Auxiliary Heat operate.

ELECTRIC AUXILIARY HEAT

If Service Menu 140 is set to "0" (electric Auxiliary Heat) the lockout control is as follows:

